



Low Dropout Linear Voltage Regulator

● Features

- Output Voltage selectable in 100mV steps (1.2V to 5.0V)
- Highly Accurate
- Low Dropout Voltage
- Low Power Consumption
- Internal current limiting and short protecting
- Small packages

● Applications

- Battery powered equipment
- Reference voltage sources
- Cameras, Video cameras
- Mobile phones
- Communication tools

● General Description

The FS3302 series are precise, low power consumption, positive voltage regulators manufactured using CMOS and laser trimming technologies. The series provides large currents with a significantly small dropout voltage. The FS3302 consists of a current limit circuit, a driver transistor, a precision reference voltage and an error correction circuit. The series is compatible with low ESR ceramic capacitors. The current limiter's foldback circuit also operates as a short protect for the output current limiter and the output pin. Output voltage can be set internally by laser trimming technologies. It is selectable in 100mV increments within a range of 1.2V to 5.0V. SOT23 packages are available.

● Pin Configurations (SOT23)

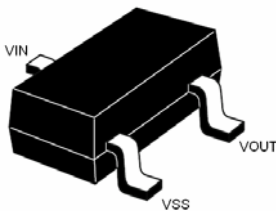

● Typical Application Circuit

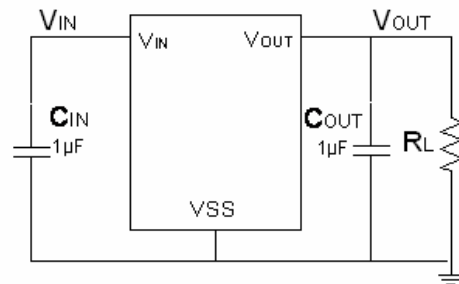

● Absolute Maximum Ratings

(Operating temperature range applies unless otherwise specified.)

Parameter	Symbol	Maximum	Units
Input Voltage	V_{IN}	-0.3 to 6.5	V
Output Current	V_{OUT}	$V_{SS}-0.3$ to $V_{IN}+0.3$	
Power Dissipation($T_A=25^{\circ}C$)	P_D SOT23	150	mW
Operating Temperature Range	T_{OPR}	-40 to +125	$^{\circ}C$
Storage Temperature Range	T_{STG}	-65 to +150	$^{\circ}C$

●



● Ordering Information

FS3302-①②③④

DESIGNATOR	SYMBOL	DESCRIPTION
①②	Output Detection Voltage	... 15=1.5V, 18=1.8V, 25=2.5V,28=2.8V, 30=3.0V, 33=3.3V
③④	Package Type:	SI: SOT23

● Electrical Characteristics

$V_{IN} = V_{OUT} + 1V$, $V_{EN} = V_{IN}$, $C_{IN} = C_{OUT} = 1\mu F$, $T_J = 25^\circ C$ unless otherwise specified

Item	Symbol	Condition	Test Circuit	Min	Typ	Max	Unit
Input Voltage	V_{IN}	--	--	1.8	--	6.5	V
Supply Current	I_{SS}	$V_{IN} = V_{OUT} + 1.0 V$	2	--	4	--	μA
Output Voltage	V_{OUT}	$V_{IN} = V_{OUT} + 1.0 V$, $I_{OUT} = 40 mA$	1	$V_{OUT(T)}^x$ 0.98	$V_{OUT(T)}$	$V_{OUT(T)}^x$ 1.02	V
Output Current	I_{OUT}	$V_{IN} \geq V_{OUT} + 1.0 V$	1	300	--	--	mA
Dropout Voltage	V_{DROP}	$I_{OUT} = 100mA$	1	$1.5 V \leq V_{OUT} \leq 2.5 V$	0.20	0.28	V
				$2.6 V \leq V_{OUT} \leq 3.3 V$	0.16	0.24	
				$3.4 V \leq V_{OUT} \leq 5.0 V$	0.12	0.20	
Line Regulations	$\frac{\Delta V_{OUT}}{\Delta V_{IN} \cdot V_{OUT}}$	$V_{OUT} + 0.5 V \leq V_{IN} \leq 5.5 V$ $I_{OUT} = 80 mA$	1	--	0.05	0.3	%/V
Load Regulations	ΔV_{OUT}	$V_{IN} = V_{OUT} + 1.0 V$ $1.0 mA \leq I_{OUT} \leq 80 mA$	1	--	20	40	mV
Output Voltage Temperature Characteristics	$\frac{\Delta V_{OUT}}{\Delta T_A \cdot V_{OUT}}$	$V_{IN} = V_{OUT} + 1.0 V$, $I_{OUT} = 10 mA$ $-40^\circ C \leq T_A \leq 85^\circ C$	1	--	± 100	--	ppm/ $^\circ C$
Ripple Rejection	PSRR	$V_{IN} = V_{OUT} + 1.0 V$, $f = 1.0 kHz$ $V_{drip} = 0.5 V_{rms}$, $I_{OUT} = 80 mA$	1	--	40	--	dB
Short current	I_{SHORT}	$V_{IN} = V_{OUT} + 1.5 V$	1	--	30	--	mA
Maximum Output Current	I_{OUT}	$V_{IN} = V_{OUT} + 1V$	1	380	--	--	mA

Note:

- $V_{out(T)}$ = Specified output Voltage
- $V_{out(E)}$ = Effective output Voltage (i.e. the output voltage when " $V_{out(T)}+1.0V$ " is provided at the V_{IN} pin while maintaining a certain I_{out} value)
- $V_{drop} = \{ V_{IN1} (\text{note5}) - V_{OUT1} (\text{note4}) \}$
- V_{out1} = A voltage equal to 98% of the output voltage whenever an amply stabilized $I_{out} (V_{out(T)} + 1.0V)$ is input.
- V_{IN1} = The input voltage when $V_{out} = V_{OUT1}$



Test Circuit 1:

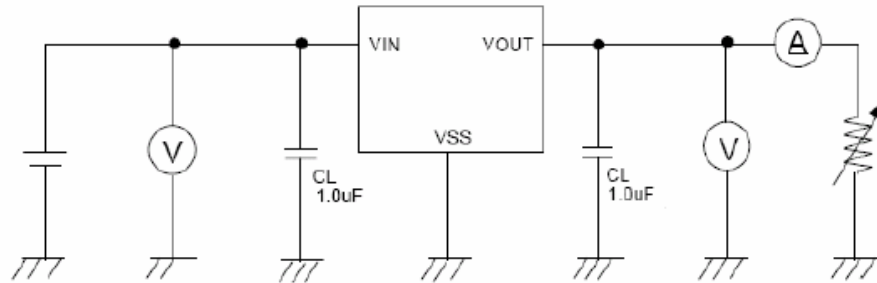

Test Circuit 2

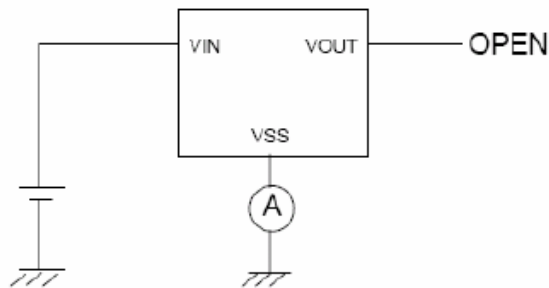

- Typical Block Diagram

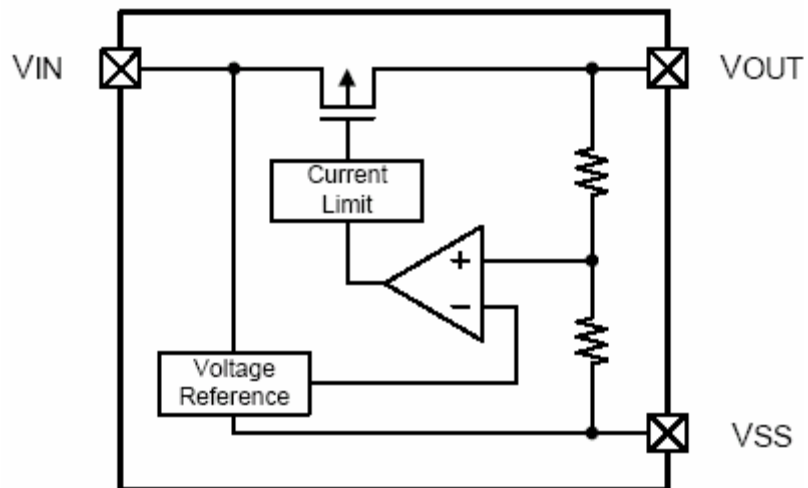



● **Typical Performance Characteristics** (3.0V Out unless otherwise specified)

1. Output Voltage vs. Output Current

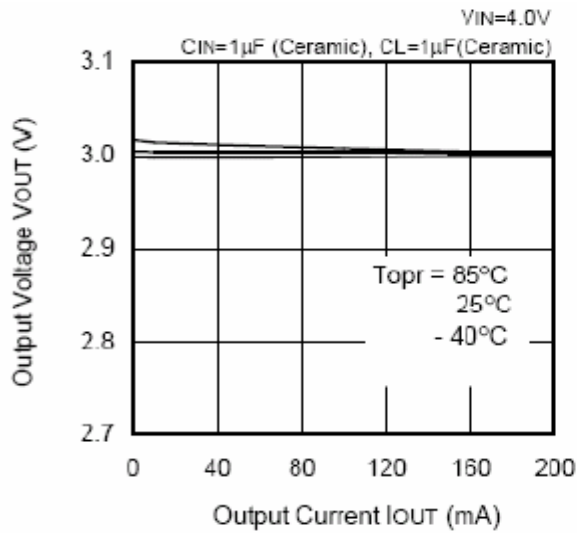

2. Output Voltage vs. Input Voltage

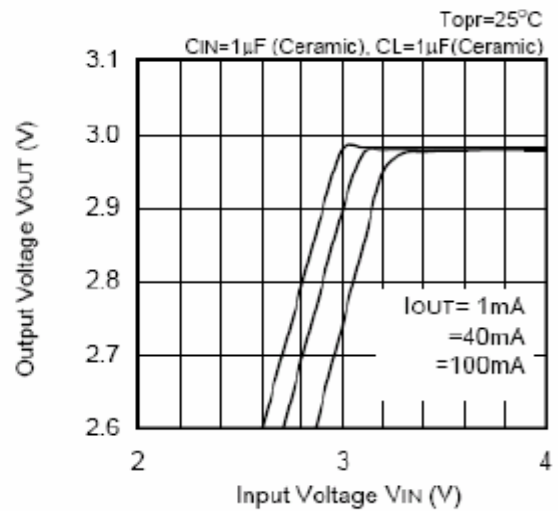

3. Dropout Voltage vs. Output Current

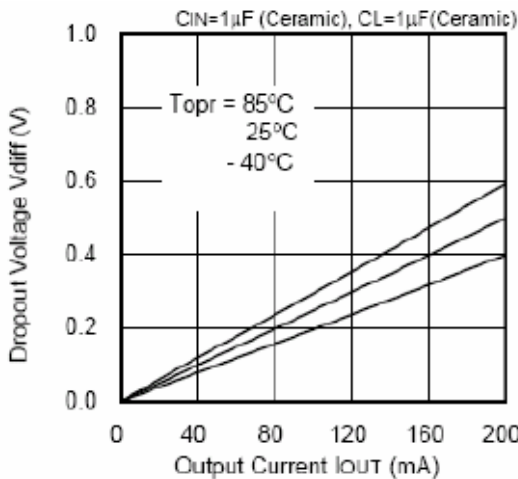

4. Dropout Voltage vs. Output Voltage

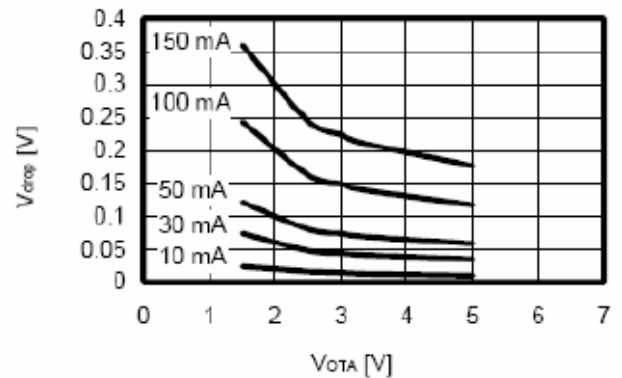

5. Output Voltage vs. Ambient Temperature

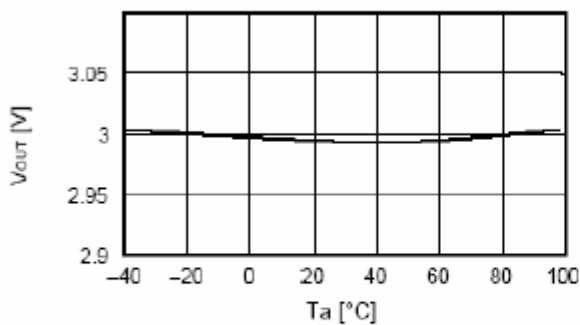

6. Ripple Rejection Rate

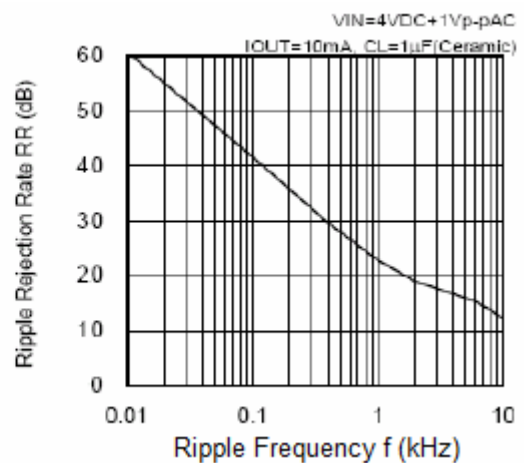



● **Typical Performance Characteristics** (3.0V Out unless otherwise specified)

7. Input Transient Response

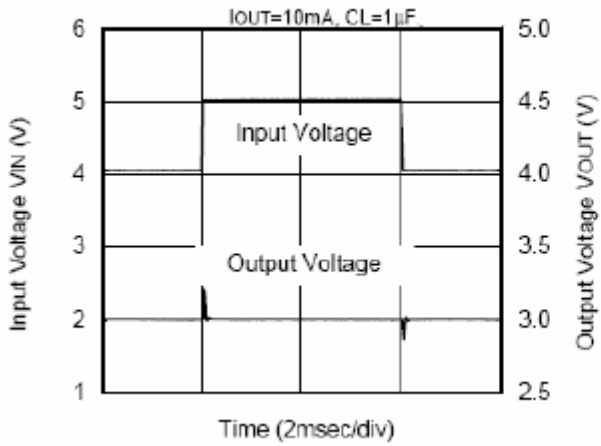

8. Load Transient Response

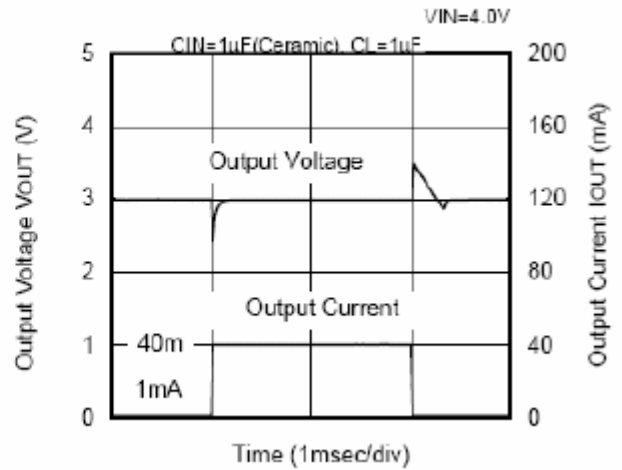

● **Package Information**

SOT-23 PACKAGE OUTLINE DIMENSIONS

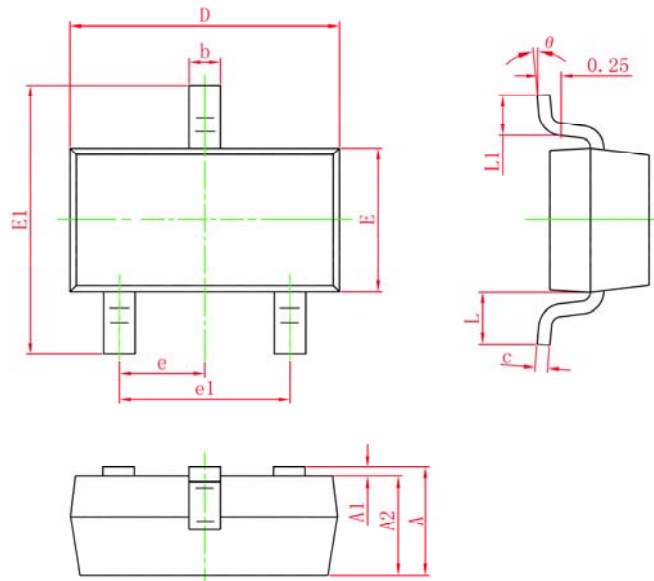

Symbol	Dimensions In Millimeters		Dimensions In Inches	
	Min.	Max.	Min.	Max.
A	0.900	1.150	0.035	0.045
A1	0.000	0.100	0.000	0.004
A2	0.900	1.050	0.035	0.041
b	0.300	0.500	0.012	0.020
c	0.080	0.150	0.003	0.006
D	2.800	3.000	0.110	0.118
E	1.200	1.400	0.047	0.055
E1	2.250	2.550	0.089	0.100
e	0.950 TYP.		0.037 TYP.	
e1	1.800	2.000	0.071	0.079
L	0.550 REF.		0.022 REF.	
L1	0.300	0.500	0.012	0.020
θ	0°	8°	0°	8°