



# Low Dropout Linear Voltage Regulator

## ● Features

- Low Power Consumption 65μA
- Dropout Voltage: 150mV @ 100mA
- Output Current: more than 200mA
- Thermal Shutdown Protection
- Highly Accurate: ± 2%
- Typical 300mA Current Limit

## ● Applications

- Battery powered equipment
- Reference voltage sources
- Cameras, Video cameras
- Portable AV systems
- Mobile phones
- Communication tools

## ● General Description

The FS3303 series are CMOS precise, low power consumption, high voltage; positive voltage regulators designed for portable applications with low quiescent current ( 65μA ) and dropout voltage ( 150mV at 100mA ).

The FS3303 have typical current limit of 300mA and are available in high accuracy ( 2% ), The output voltages are 1.2V、 1.5V、 1.8V、 2.0V、 2.5V、 3.0V、 3.3V 、 5.0V and adjust. These products feature thermal shutdown protection and current limit with fold-back in short circuit. SOT23-5L packages are available.

## ● Pin Configurations (SOT23-5L)

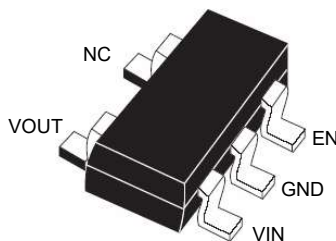

## ● Typical Application Circuit

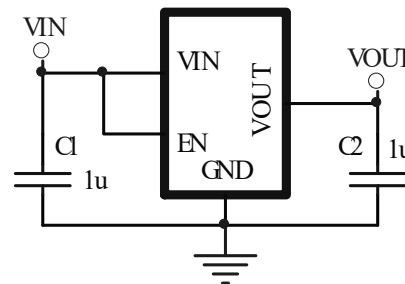

## ● Absolute Maximum Ratings

Parameter	Symbol	Ratings	Unit
IN Supply Voltage	V <sub>IN</sub>	-0.3 TO 8	V
OUT Voltage	V <sub>OUT</sub>	-0.3V to V <sub>IN</sub> +0.3	V
EN Voltage		-0.3V to 8	V
Continuous OUT Current	I <sub>MAX</sub>	Internally limited	
Power Dissipation ( T <sub>AMB</sub> = 25°C )	P <sub>D</sub>	300	mW
Operating Temperature	T <sub>OPR</sub>	-25 to +85	°C
Storage Temperature Range	T <sub>STG</sub>	-40 to +125	°C



● Ordering Information

FS3303-①②③④

DESIGNATOR	SYMBOL	DESCRIPTION
①②	Output Detection Voltage	...12=1.2V 15=1.5V, 18=1.8V, 28=2.8V, 30=3.0V, 33=3.3V...
③④	Package Type:	SL: SOT23-5L

● Electrical Characteristics

$V_{IN} = V_{OUT} + 1V$ ,  $V_{EN} = V_{IN}$ ,  $C_{IN} = C_{OUT} = 1\mu F$ ,  $T_J = 25^\circ C$  unless otherwise specified

Parameter	Symbol	Test Conditions	Min	Typ	Max	Unit
Operating Voltage	$V_{in}$		2.5		5.5	V
Output Voltage Accuracy	$\Delta V_{OUT}$		-2	0	2	%
Line Regulation		$V_{IN} = V_{OUT} + 1V$ to 8V		6		mV
Load Regulation		$I_{OUT} = 1mA$ to 100 mA		20		mV
Power Supply Rejection Ratio	PSRR	$V_{IN} = V_{OUT} + 1V_{P-PAC}$ , $F = 1 KHz$ , $I_{OUT} = 40mA$ $C_{OUT} = 1\mu F$		60		dB
Supply Current	$I_q$	$EN = 1.4V$		65	90	$\mu A$
		$EN = 0.4V$		0.6	1	
Dropout Voltage	$V_{DO}$	$I_{OUT} = 100mA$		140	170	mV
Current Limit	$I_{LIM}$			300		mA
Current Limit Short Circuit	$I_{LIMSC}$			80		mA
Output Noise	$e_n$	$C_{OUT} = 1\mu F$ , $I_{OUT} = 40mA$ , $F = 300Hz$ to 50KHz		50		$\mu V_{RMS}$
EN Input Logic Low Threshold	$V_{IL}$	$T_J = -40^\circ C$ to $125^\circ C$			0.3	V
EN Input Logic High Threshold	$V_{IH}$	$T_J = -40^\circ C$ to $125^\circ C$	1.3			V
EN Input Current		$V_{EN} = V_{IN} = 5.5V$		0	0.1	$\mu A$

● Typical Block Diagram

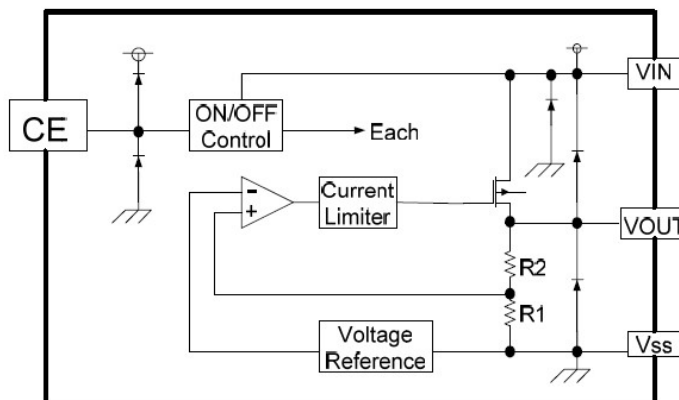



● Pin Description

Pin No.	Pin Name	Pin Function
1	IN	Input positive power pin of FS3303.
2	GND	Ground
3	EN	Enable Input. High level enables the LDO. Connect this pin to IN if not used; do not leave EN unconnected.
4	NC	Not use
5	OUT	Output pin.

● Typical Performance Characteristics

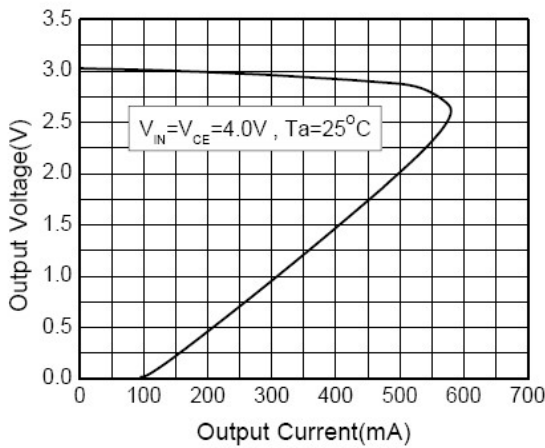

Figure 1. Output Voltage vs. Output Current

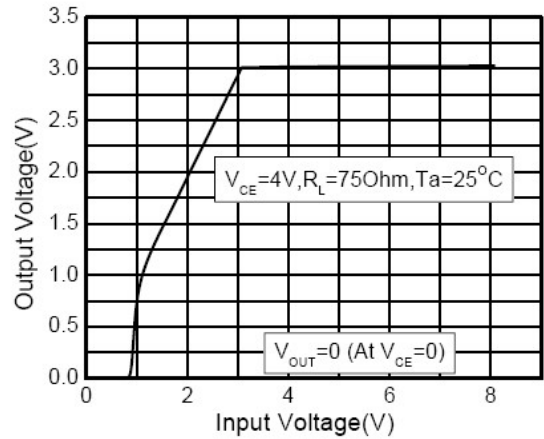

Figure 2. Output Voltage vs. Input Voltage

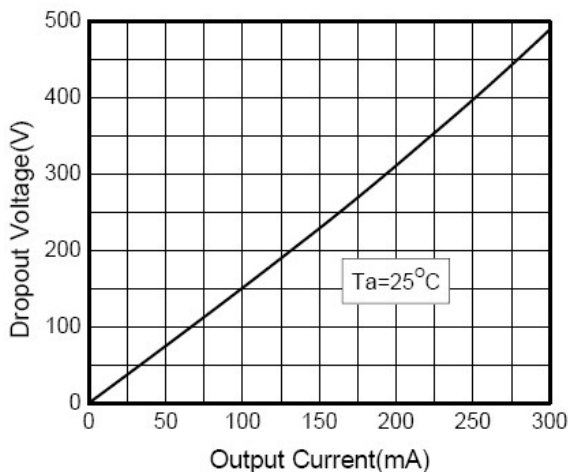

Figure 3. Dropout Voltage vs. Output Current

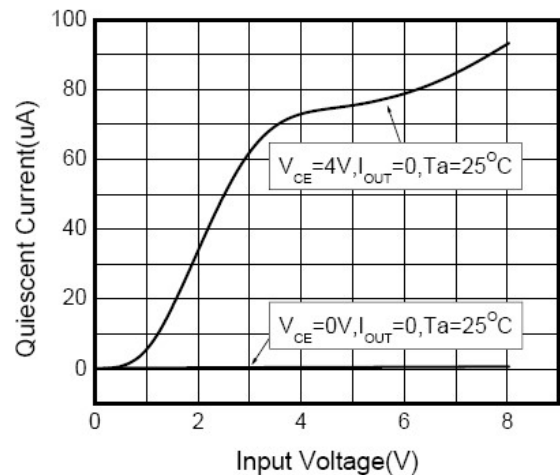

Figure 4. Quiescent Current vs. Input Voltage

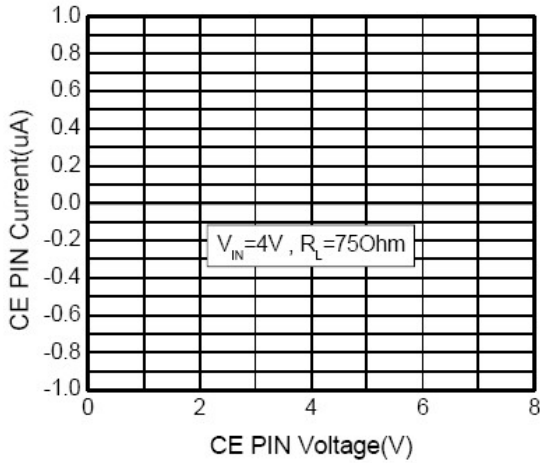

Figure 5. CE PIN Current vs. CE PIN Voltage

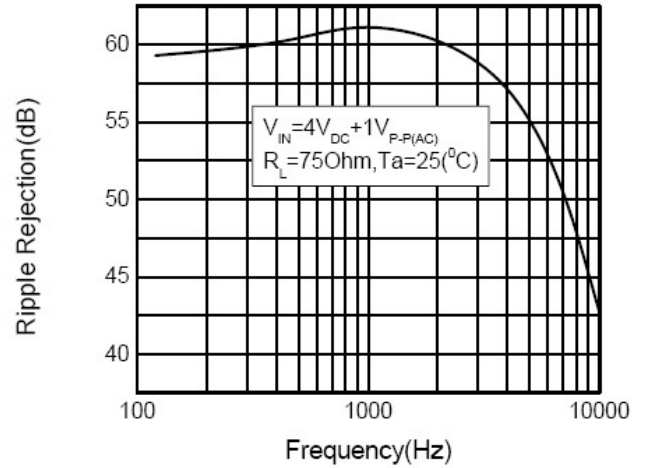

Figure 6. Power Supply Rejection Ratio

● Typical Performance Characteristics

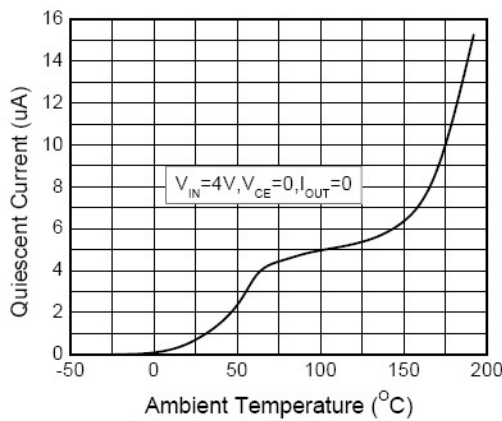

Figure 7. Quiescent Current vs. Ambient Temperature

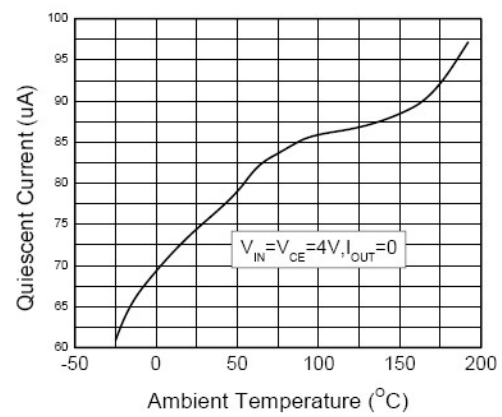

Figure 8. Quiescent Current vs. Ambient Temperature

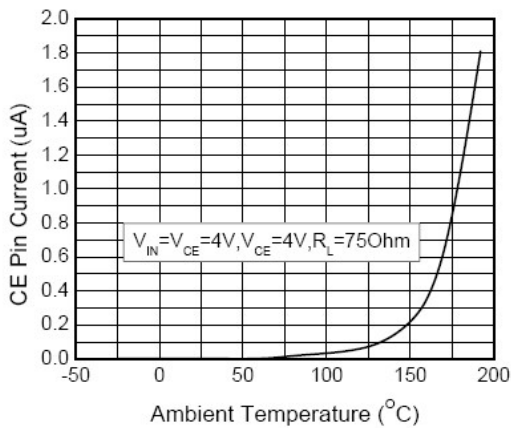

Figure 9. CE Pin Current vs. Ambient Temperature

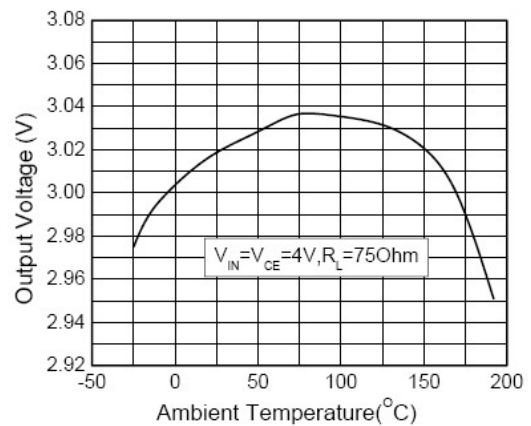
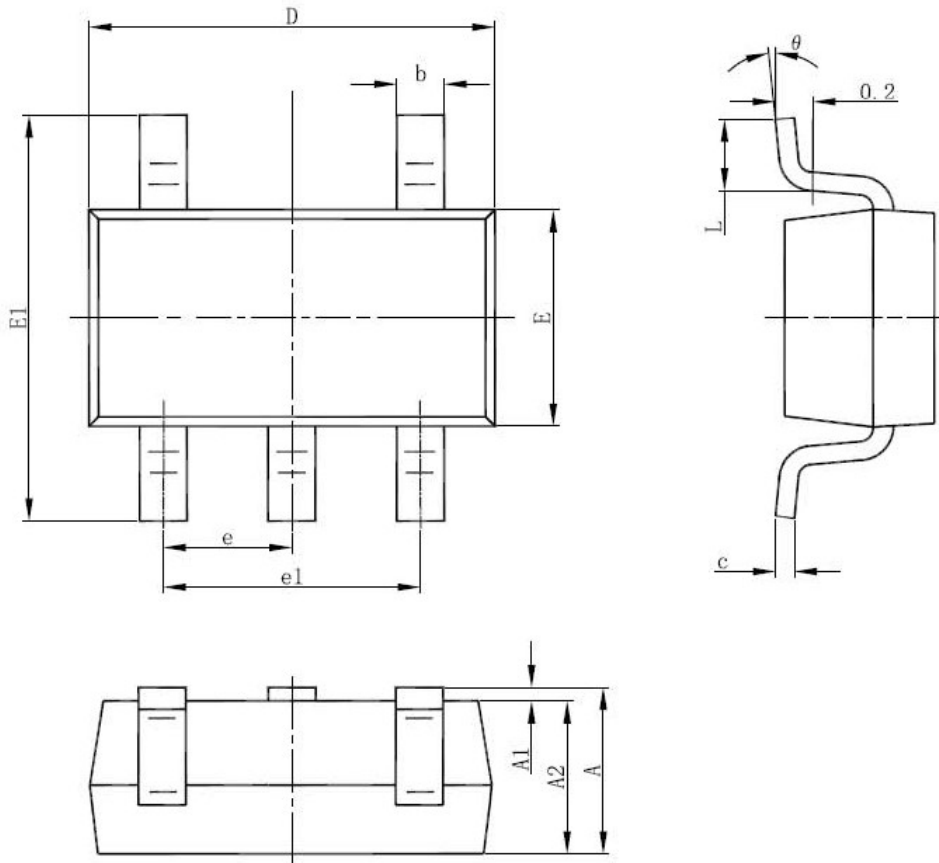

Figure 10. Output Voltage vs. Ambient Temperature



● Package Information

**SOT-23-5L PACKAGE OUTLINE DIMENSIONS**



Symbol	Dimensions In Millimeters		Dimensions In Inches	
	Min	Max	Min	Max
A	1.050	1.250	0.041	0.049
A1	0.000	0.100	0.000	0.004
A2	1.050	1.150	0.041	0.045
b	0.300	0.500	0.012	0.020
c	0.100	0.200	0.004	0.008
D	2.820	3.020	0.111	0.119
E	1.500	1.700	0.059	0.067
E1	2.650	2.950	0.104	0.116
e	0.950(BSC)		0.037(BSC)	
e1	1.800	2.000	0.071	0.079
L	0.300	0.600	0.012	0.024
θ	0°	8°	0°	8°