



35V, 1.6 μ A High Driver LDO Regulator

■ Features

- Low Power Consumption 1.6 μ A (TYP.)
- Low voltage drop
- Low temperature coefficient
- High input voltage (Up to 35V)
- High input current:250mA
- Low power consumption
- Ceramic compatible
- SOT89 & SOT23 package

■ Product information

- Package type

FS5350BSI	SOT23
FS5350BSJ	SOT23-3
FS5350BSK	SOT23-5
FS5350BSM	SOT89-3
FS5350BTE	TO92

- Output Voltage Accuracy
FS5350B \pm 2%

■ General Description

The FS5350B series is a set of three-terminal high current low voltage regulator implemented in CMOS technology. They can deliver 150mA output current and allow an input voltage as high as 35V. They are available with several fixed output voltages ranging 3.0V 3.3V 3.6V 5.0V. CMOS technology ensures low voltage drop and low quiescent current

Although designed primarily as fixed voltage regulators, these devices can be used with external components to obtain variable voltages and currents.

■ Typical Application Circuit

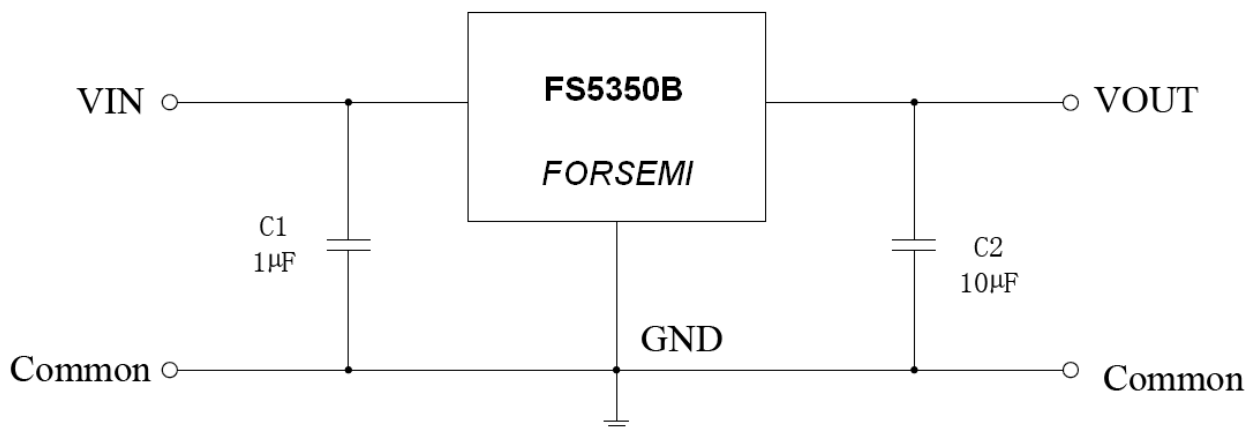



■ Package Information

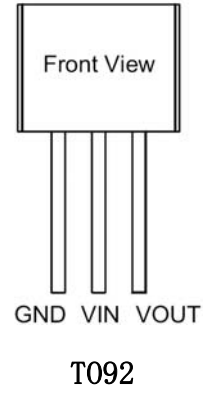
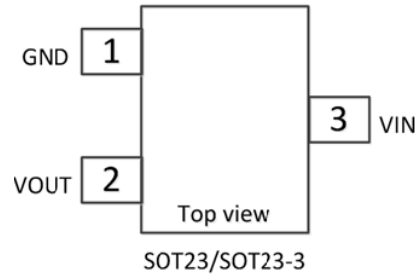
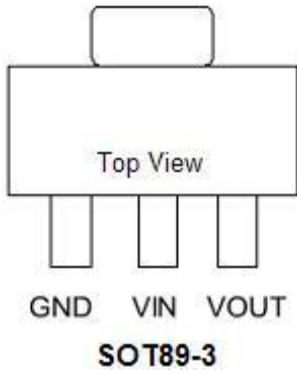

■ 方框图

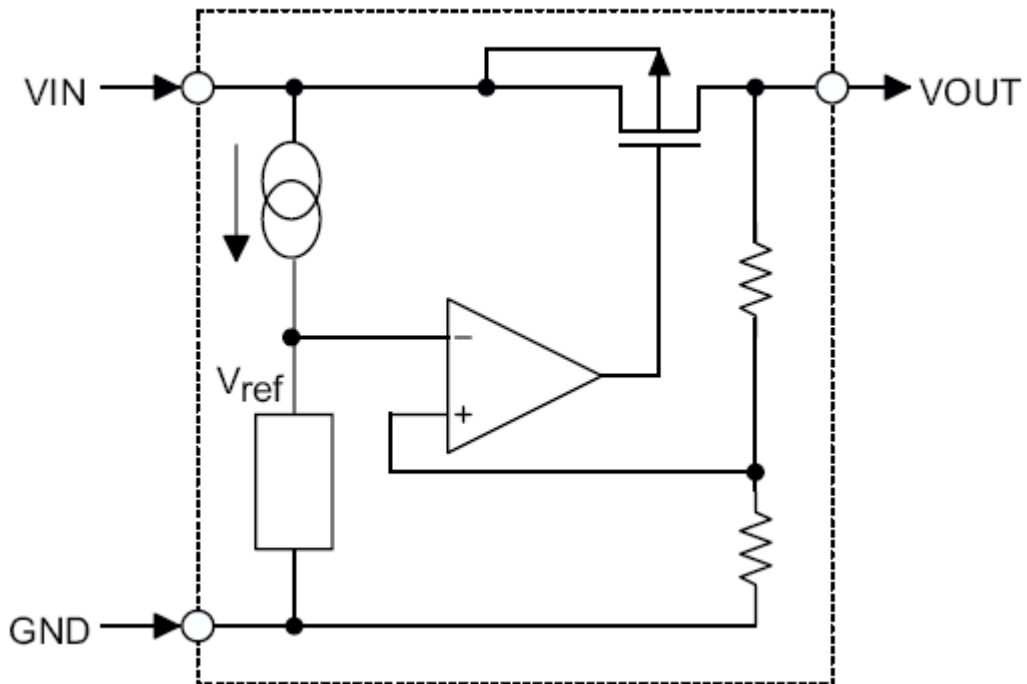



■ Absolute Maximum Ratings

Parameter	conditions	Min	Max	Units
Voltage	VIN to GND	-0.3	40	V
	VOUT to GND	-0.3	6	V
	VOUT to VIN	-35	0.3	V
Current	Peak Current	Innel		
Temperature.	Operating Temperature	-40	85	°C
	Storage Temperature	-40	150	°C
	Junction Temperature	-	150	°C
Thermal resistance	SOT23	350		°C/W
	SOT23-3	350		°C/W
	SOT23-5	260		°C/W
	SOT89-3	165		°C/W
	TO92	180		°C/W
Power Consumption	SOT23	350		mW
	SOT23-3	350		mW
	SOT23-5	480		mW
	SOT89-3	750		mW
	TO92	690		mW
ESD Rating	HBM	-	1	kV
	MM	-	100	V

Note:

These are stress ratings only. Stresses exceeding the range specified under Absolute Maximum Ratings may cause substantial damage to the device. Functional operation of this device at other conditions beyond those listed in the specification is not implied and prolonged exposure to extreme conditions may affect device reliability.



■ **Electrical Characteristics** ($T_A=25^{\circ}\text{C}$, $C_{IN}=1\mu\text{F}$, $V_{IN}=V_{OUTNOM}+1\text{V}$, $C_{OUT}=10\mu\text{F}$)

Symbol	Parameter	Test Conditions	Min	Typ	Max	Unit
VIN	Input Voltage		3		35	V
IGND	Current Consumption	No load		1.6	2.0	μA
VOUT(FS5350 B)	Output Voltage	IOUT=10mA	-2%		2%	VOUT
IOUT	Output Current		200	250	—	mA
VDROP	Dropout*1 (FS5350B-5V0)	IOUT=10mA $\Delta V_{OUT} = -V_{OUTNOM} * 2\%$	—	30	50	mV
		IOUT=100mA $\Delta V_{OUT} = -V_{OUTNOM} * 2\%$	—	300	400	mV
		IOUT=200mA $\Delta V_{OUT} = -V_{OUTNOM} * 2\%$	—	600	750	mV
	Dropout (FS5350B-3V3)	IOUT=10mA $\Delta V_{OUT} = -V_{OUTNOM} * 2\%$	—	30	50	mV
		IOUT=100mA $\Delta V_{OUT} = -V_{OUTNOM} * 2\%$	—	300	400	mV
		IOUT=200mA $\Delta V_{OUT} = -V_{OUTNOM} * 2\%$	—	600	750	mV
ΔV_{OUT}	Load Regulation	$1\text{mA} \leq I_{OUT} \leq 100\text{mA}$	—	20	50	mV
$\Delta V_{OUT} \times 100 / \Delta V_{IN} \times V_{OUT}$	Line Regulation	IOUT=1mA, VIN=(VOUTNOM+1V) to 30V	—	—	0.2	%/V
ILIMIT	Current limited Protection	VIN=(VOUTNOM+1V) to 30V RLOAD=VOUTNOM/1A		450		mA
TSHDN	Temperature Protection			125		$^{\circ}\text{C}$
TCVOUT	Temperature Coefficient	IOUT=10mA $-40^{\circ}\text{C} \leq T_{AMB} \leq 100^{\circ}\text{C}$		± 100		ppm/ $^{\circ}\text{C}$

注 : *1 Dropout

1. $V_{drop} = \{ V_{IN1} (\text{note3}) - V_{OUT1} (\text{note2}) \}$
2. V_{out1} = A voltage equal to 98% of the output voltage whenever an amply stabilized I_{out} ($V_{out(T)} + 1.0\text{V}$) is input.
3. V_{IN1} = The input voltage when $V_{out} = V_{OUT1}$

$$PD(\text{MOSFET}) = (V_{IN} - V_{OUT}) \times I_{OUT}$$

$$PD(\text{TOTAL}) = PD(\text{MOSFET}) + V_{IN} \times I_{GND}$$

$$T_J = PD(\text{max}) \times \theta_{JA} + T_A$$

θ_{JA} is Thermal resistance, T_A is environment Temperature



■ Typical Performance Characteristics

Output Voltage vs. Output Current

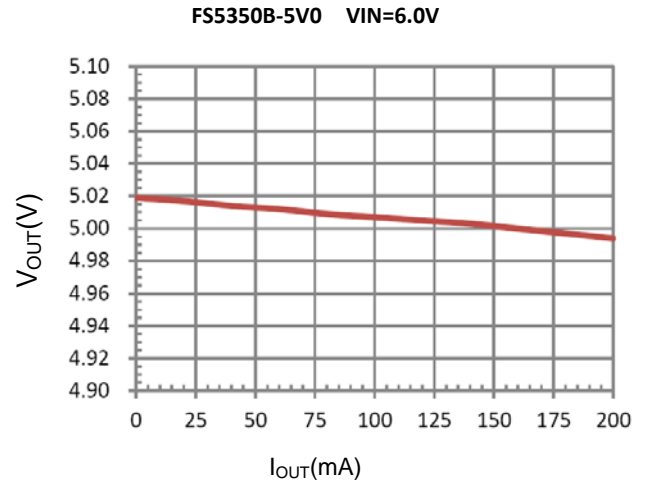
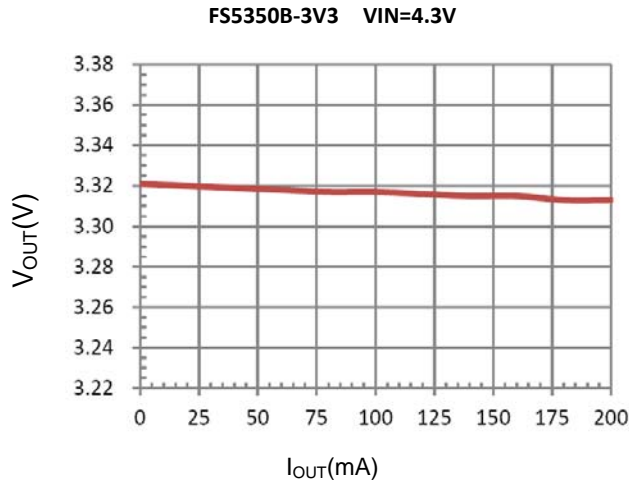

Output Voltage vs. Input Voltage

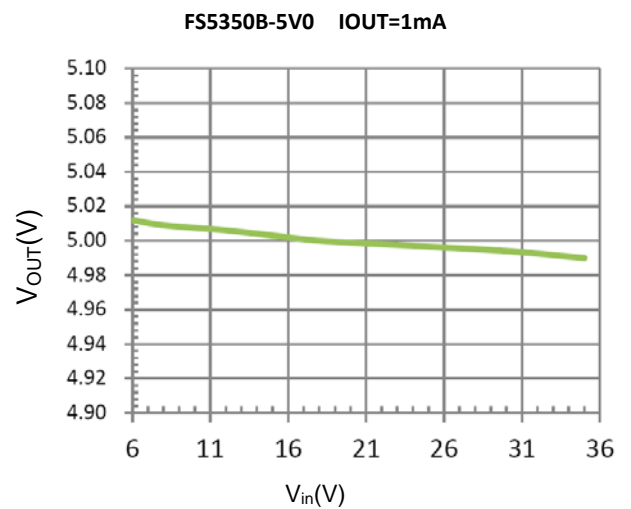
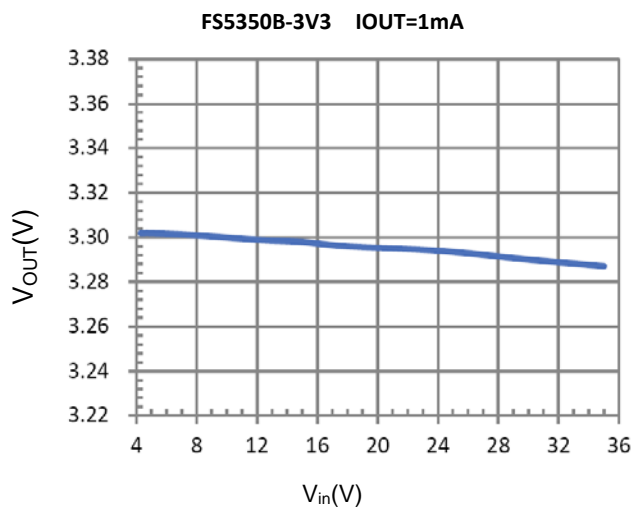

Output Voltage vs. Ambient Temperature

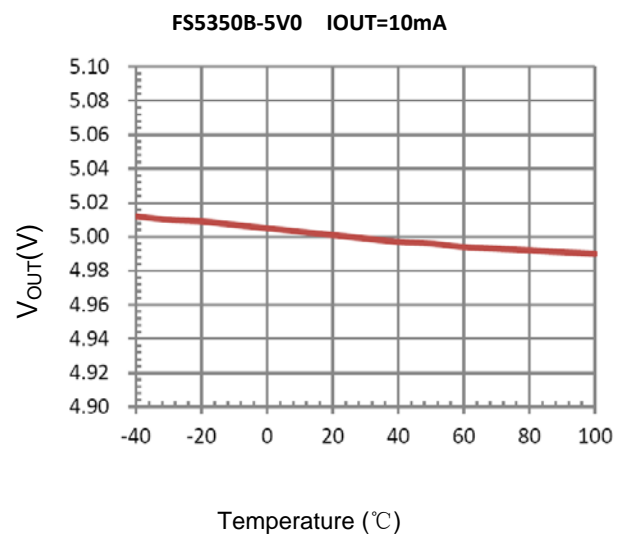
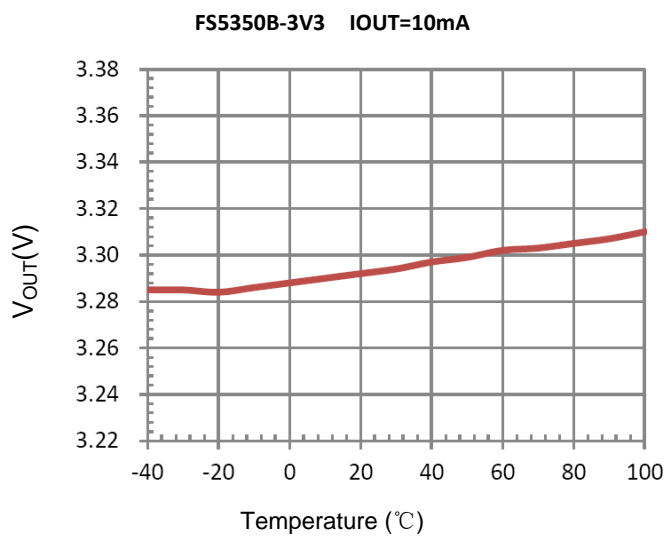



Supply Current vs. Input Voltage

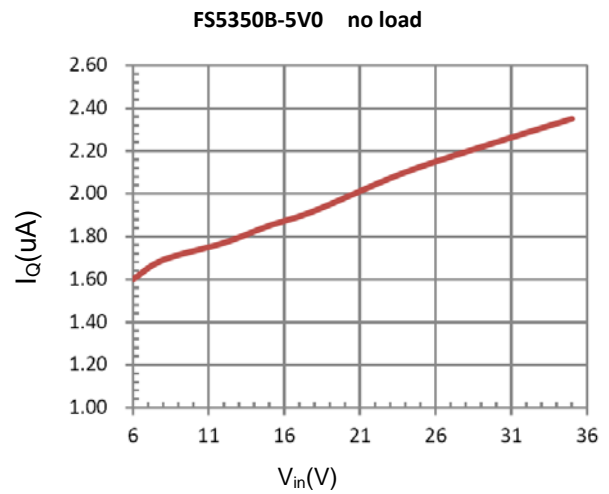
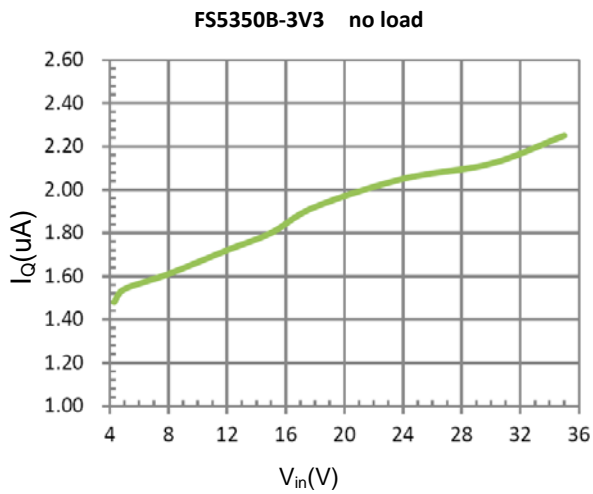

GND Current vs. output current

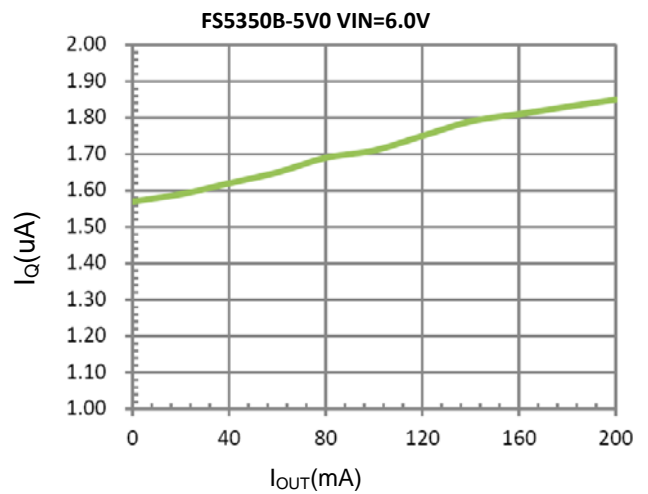
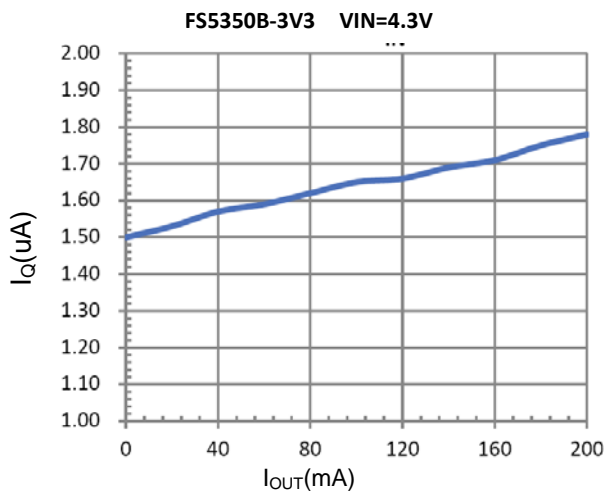

Supply Current vs. Ambient Temperature

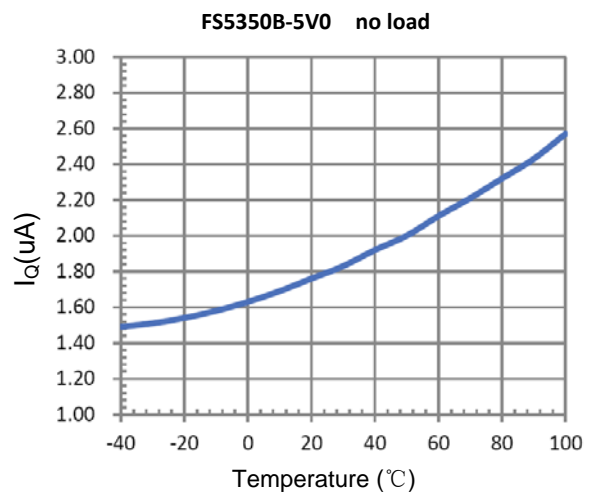
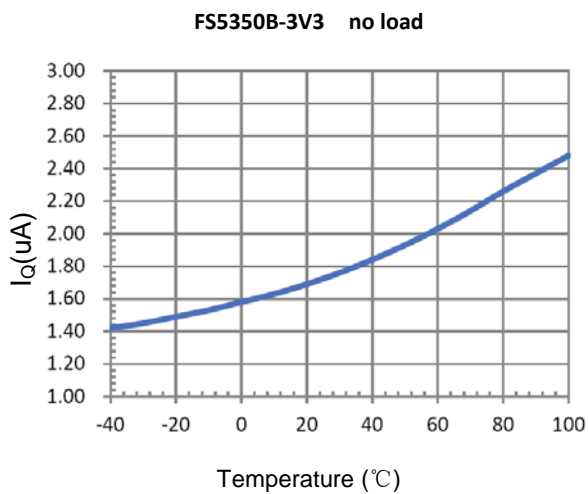



The start up Response

No load COUT=10uF

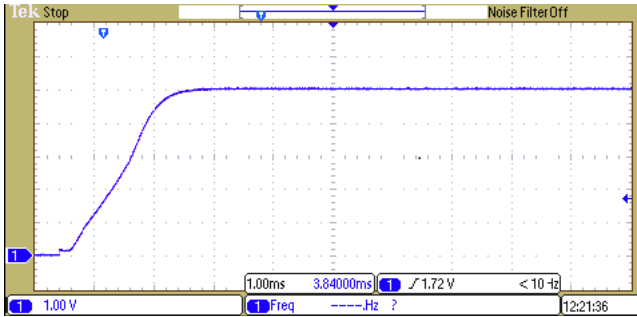

Iload=30mA start up COUT=10uF

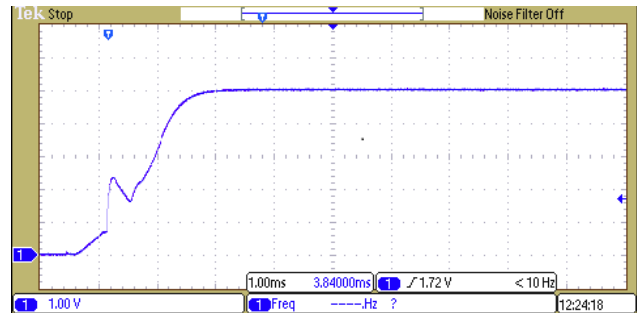

Load Transient Response

VIN=12.0V, COUT=10uF, IOUT=10mA to 200mA

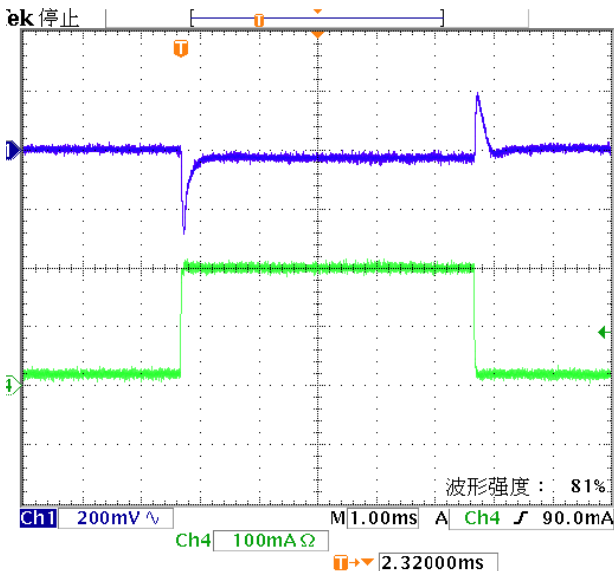

Input Transient Response

VIN=5.0V to 12.0V, COUT=10uF, IOUT=1mA

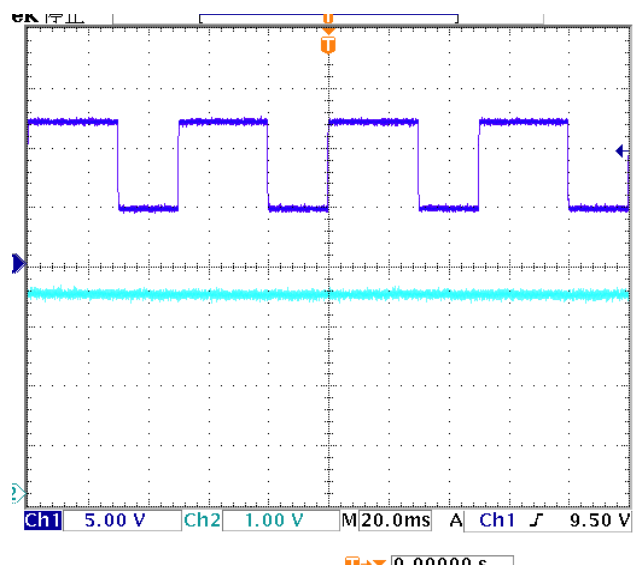

Short Protection & release

VIN=25V, Short Protection occur

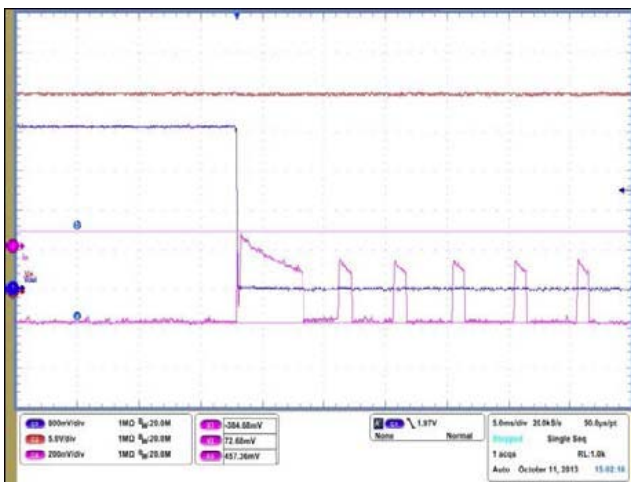

VIN=25V, Short Protection release

